

**GREEN SYNTHESIS AND
CHARACTERIZATION OF ZINC NANOPARTICLES**

A Project report submitted to
Mahatma Gandhi University, Kottayam
in partial fulfillment of requirement for the award of the degree of

B.Sc CHEMISTRY

BY

CHANJAL JACOB

(Reg. No.170021025607)



Under the supervision of

Dr. MARY JOSEPH

DEPARTMENT OF CHEMISTRY

BHARATA MATA COLLEGE THRIKKAKARA

(Affiliated to Mahatma Gandhi University, Kottayam)

2017-2020

DEPARTMENT OF CHEMISTRY



BHARATA MATA COLLEGE

Thrikkakara, Kochi-21

Affiliated to MG University, accredited by NAAC with 'A+' Grade

CERTIFICATE

This is to certify that the Project titled“ **GREEN SYNTHESIS AND CHARACTERIZATION OF ZINC NANOPARTICLES**” is a bonafide work carried out by **CHANJAL JACOB**, Reg No: **170021025607**, B.Sc Chemistry student, under the supervision and guidance and that no part of this has been presented earlier for the award of any other degree, diploma or other similar titles of recognition.

Forwarded by

Dr. LITTY SEBASTIAN

Head of the Department

Department of Chemistry

Bharata Mata College, Thrikkakara

Project Guide

Dr. MARY JOSEPH

Professor

Department of Chemistry

Bharata Mata College, Thrikkakara

Place:.....

Date:.....

DECLARATION

I, CHANJAL JACOB, declare that the project report entitled "GREEN SYNTHESIS AND CHARACTERIZATION OF ZINC NANOPARTICLES", submitted to Mahatma Gandhi University, Kottayam, in partial fulfillment for the award of the degree of BSc Chemistry, is an authentic record of original work done by me, under the supervision of Prof. MARY JOSEPH, Department of Chemistry, Bharata Mata College, Thrikkakara and no part of this has been previously formed on the basis for the award of any degree or assistantship of any other institution.

Place:.....

CHANJAL JACOB

Date:.....

ACKNOWLEDGEMENT

First and foremost, I thank God almighty, being the unfailing source of support, comfort and strength throughout the successful completion of my work.

With great appreciation, I would like to express my sincere gratitude to Dr. Litty Sebastian, Head of the Department, for her valuable suggestions, guidance and support throughout the accomplishment of my project.

Words are inadequate to express my sincere gratitude to my guide, Prof. Mary Joseph, for her sustained guidance and encouragement throughout the course of this project. Without her solicitude, I would not have been able to make such a study. I am also thankful to all my teachers in the department for their kind cooperation and help.

I extend my sincere thanks to the lab assistants Mr.Shinto and Mrs.Sini for their help and kind cooperation.

On my personal note, I would like to thank my parents who gave me support and encouragement and motivated me on all my endeavors.

Finally, I would also like to thank my friends who have helped me, directly or indirectly, at the various stages of this product.

CHANJAL JACOB

CONTENTS

CHAPTER 1: INTRODUCTION AND REVIEW OF LITERATURE

- 1.1 Introduction
- 1.2 Classification of Nano materials
- 1.3 Applications
- 1.4 Applications of zinc nanoparticles
- 1.5 Synthesis of Nanomaterial
- 1.6 Characterization of Nanoparticles
- 1.7 Aims and Objectives

CHAPTER II: MATERIALS AND METHODS

- 2.1 Synthesis characterization of Zinc Nanoparticles

CHAPTER III: RESULTS AND DISCUSSIONS

- 3.1 Characterization of Zinc Nanoparticle

CHAPTER IV: CONCLUSION

CHAPTER V: REFERENCES

CHAPTER 1

INTRODUCTION AND REVIEW OF LITERATURE

1.1 Introduction

A nanoparticle is a microscopic particle with a dimension less than 100nm. Nanoparticle research is currently an area of intense scientific research, due to a wide variety of potential applications in biomedical, optical and electronic fields. Nanoparticles are of great scientific interest as they are effectively a bridge between bulk materials and atomic or molecular structures.

Nanotechnology should not be viewed as a single technique that only affects specific areas. It is more of a 'catch all' terms for a science which is benefiting a whole array of areas, from the environments to health care, to hundreds of commercial products. Although often referred to as the tiny science, nanotechnology does not simply mean very small structure and products. Nano scale features are often incorporated into bulk materials and bulk surfaces. Nanotechnology is already in many of the everyday object around us, but this is only the start. It will allow limitation in many existing technologies to be overcome and thus has the potential to be part of every industry.

Nano scale materials are already incorporated into more than 600 consumer products, including food, packaging, cosmetics, clothing and paint. Nanotechnology has been cited as the foundation of a new advanced agriculture. The future of nanotechnology is completely uncharted territory. There is the possibility that the future of nanotechnology is very bright.

Many areas of science and technology will be revolutionized by new opportunities to model, observe, understand and manipulate material structure have dimensions on the order of the size of molecules and molecular clusters. Nano science is an exciting interdisciplinary area of research for Studying materials, the chemical process, electronics, and the molecular components of living cells. It offers the ability to visualize, synthesize and manipulate structures for a wide variety of technological applications.

The Nano revolution is happening. There is no doubt that it will take its place in history alongside of the discovery and use of fire, the introduction of agriculture and industrial revolution. These revolutions happened over considerable lengths of time, even centuries. In some part of the world they are still in progress. In contrast, the Nano revolution can be expected to blossom in the next few decades. They are already happening very fast. We can expect to see dramatic changes right before our eyes.

An array of physical, chemical and biological methods has been used to synthesize nanomaterials. Specific methodologies have been used to synthesize noble metal nanoparticles of particular size and shape. Although ultraviolet irradiation, aerosol technologies, lithography, laser ablation, ultrasonic fields, and photochemical reduction techniques have been used successfully to produce nanoparticles, they remain expensive and involve the use of hazardous chemicals. Therefore, there is a growing concern to develop simple, cost-effective, and sustainable methods. As nanoparticles of different compositions, sizes, shapes and controlled disparity is an important aspect of nanotechnology, new cost effective and eco-friendly procedures are being developed.

1.2 Classification of Nano materials

Nano materials generally fall into two categories: fullerenes and inorganic nanoparticles.

1.2.1 Fullerenes

A fullerene is any molecule composed entirely of carbon, in the form of a hollow sphere, ellipsoid or tube. Spherical fullerenes also called Bucky balls, and they resemble a football. Cylindrical ones are called carbon Nano tubes or Bucky tubes. Fullerenes are similar in structure to graphite which is composed of stacked graphene sheets of linked hexagonal rings; but they also contain pentagonal ring. There also exist other carbon molecules similar to C_{60} with cage structure, collectively called 'fullerenes' in honor of the famous American architect Buckminster Fuller.

Fullerenes were under study for potential medicinal use; binding specific antibiotic to the structure of resistant bacteria and even target certain type cancer cell as melanoma.

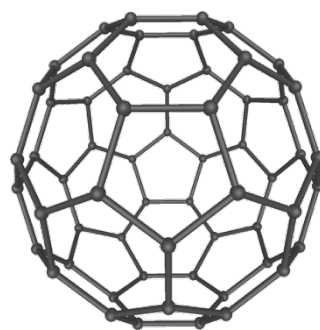

Figure 1.Fullerene

1.2.2 Carbon nanotube

Carbon nanotubes are often described as graphene are rolled up into the shape of cylinder. They are graphene cylinders about 1-2 nm in diameter and wrapped with end-containing pentagonal rings. The general principle of nanotube involves producing reactive carbon atoms at a very high temperature; these atoms then accumulate in regular patterns on the surface of metal particles that stabilize the formation of the fullerene resulting in a long chain of assembled carbon atoms.

Carbon nanotubes may be single walled (SWNT) or multi walled (MWNT'S). Depending upon the alignment of carbon atoms in the cylindrical form SWNT can be either achiral or chiral. Achiral and chiral forms can act as metals or semiconductors and yet retain the same basic nanotube structural motif.

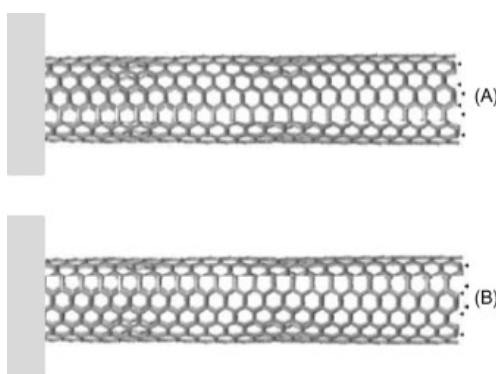

Figure2. Carbon nanotube

1.2.3 Inorganic nanoparticles

Nanoparticles made of metals, semiconductors, electrical, magnetic, optical, chemical and other properties. Nanoparticles are characterized at the nanometer scale in one, two, or three dimensions leading to quantum wells, quantum wires or quantum dots. These particles effectively act as a bridge between bulk materials and atomic or molecular structures. A bulk material should have constant physical properties, regardless of its size. Inorganic nanoparticles are mainly classified into three categories.

(i) *Inorganic nanotube*

An inorganic nanotube is a cylindrical molecule often composed of metal oxides and morphologically similar to a carbon nanotube. Inorganic nanotubes have been observed to occur naturally in some mineral deposit. Although Linus Pauling mentioned the possibility of curved layers in minerals as early as 1930, synthetic inorganic nanotubes did not appear until

ReschefTenneEtal reported the synthesis of nanotubes composed of tungsten disulfide (WS_2) in 1992. In the intervening years, nanotubes have been synthesized of many other inorganic materials such as vanadium oxide and manganese oxide and are being researched for such applications as redox catalyst and cathode materials for batteries.

The physical properties of inorganic nanotubes are relatively less explored. TiO_2 nanotubes may be useful as well purge active bioactive surface layers on titanium implant metals for orthopedic and dental implants, as well as for photo catalyst and other sensor applications.

(ii) Nanowire

A nanowire is a nanostructure, with the diameter of the order of a nanometer (10^{-9} meters). Alternatively, nanowires can be defined as structures that have a thickness or diameter constrained to tens of nanometer or less and an unconstrained length. At these scales, quantum mechanical effects are important which coined the term “quantum wires”. Many different types of nanowires exist, including metallic (Ni, Pt, Au), semiconducting (Si, InP, GaN, etc.), and insulating (SiO_2 , TiO_2). Molecular nanowires are composed of repeating molecular units either organic (DNA) or inorganic ($MO_6S_{9-x}I_x$).

Nanowires have many interesting properties that are not seen in bulk or 3-D materials. This is because electrons in nanowires are quantum confined laterally and thus occupy energy levels that are different from the traditional continuum of energy levels or bands found in bulk materials. The nanowires could be used, in the near future, link tiny components into extremely small circuits.

(iii) Quantum dots

Quantum dots are tiny particles, or “nanoparticles”, of a semiconductor material, traditionally chalcogenides (selenides or sulfides) of metals like cadmium or zinc ($CdSe$ or ZnS for example), which range from 2 to 10 nanometers in diameter. Because of their small size, quantum dots display unique optical and electrical properties that are different in character to those of the corresponding bulk material. The most immediately apparent of these is the emission of photons under excitation, which are visible to the human eyes as light.

1.3 Applications

Ability of materials to dramatically change their property at nanoscale has opened up the possibility of marketing new devices, instruments and consumer goods to function in much better ways than was possible earlier. Rapid progress in synthesis and understanding of Nanomaterials in just a few years had led them to enter the world market in a big way.

1.3.1 Electronics

Single electron transistor (SET), spin valves, and magnetic tunnel junction are conceptually new devices based on nanotechnology. Such devices are fast, compact, relatively cheap and are finding their way to market. Spin valve devices are already being used in personal computers to read disc which have enabled to increase data storage capacity of hard disc. The flat panel television or computer monitors are products of nanotechnology. Even the coatings used for screens of TV or monitors can be of nanoparticles, which have better properties in terms of color quality and resolution than micro particle coatings.

1.3.2 Energy

Nanotechnology will play an important role in the field of energy. We will know that natural energy resources are limited and depleting very fast. The future generations will have to look for alternative sustainable energy sources. There is a considerable amount of research going on to tap hydrogen fuel by splitting water using sunlight in presence of nanomaterials. Material like carbon nanotubes is a special class of Nanomaterials being investigated for its potential use as hydrogen storage material. There are also attempts going on to increase the efficiency of solar cells for energy production using nanoparticles.

1.3.3 Automobiles

Even a simple car is made up of a large number of parts and materials. Body structure should be strong, non-deformable or rigid, desirable shape and size. Nanotube composites have mechanical strength better than even steel. Attempts are made to make composites that can replace steel. Nanoparticle paints provide smooth, thin, attractive coating. Some research is going on to explore the possibility of applying a small voltage to change the color of the cars as desired. Very powerful motors known as shape memory alloys are made using nanoparticles of material like Ni-Ti. They perform better and less power hungry than other motors. Such motors are finding their way in automobiles.

1.3.4 Textiles

Textile industry is also quite excited about nanomaterials. Special threads and dyes used in this industry are products of nanotechnology. Some companies are using even silver nanoparticle in washing machines which clothes germ free. Use of silver nanoparticles assures germ-free environment necessary for bandages, surgical purposes and child-care items.

1.3.5 Cosmetics

Nanoparticles are also important in cosmetics. Zinc oxide and Titanium oxide nanoparticles of fairly uniform size are able to absorb UV light and protect the skin. Some creams using nanoparticles are already marketed. Nano-based dyes and color are quite harmless to skin and can be used in hair creams and gels.

1.3.6 Biotechnology and Medical field

Initial tests of various drug delivery systems, cancer or tumor therapies or detection have been successful using nanotechnology. Nanoparticles being very small are easy to inject and target towards specific portion in a body. Image certain parts of body like in dentistry, bone etc., Nano phosphors are being used. Semiconducting nanoparticles or quantum dots are highly fluorescent materials and can be used.

1.4 Applications of Zinc Nanoparticles

Zinc oxide nanoparticles (ZnO NPs), as one of the most important metal oxide nanoparticles, are popularly employed in various fields due to their peculiar physical and chemical properties. They are used in an increasing number of industrial products such as rubber, paint, coating, and cosmetics.

1.4.1 Biomedical applications

Recently, biomedical nanomaterials have received more concerns because of their prominent biological characteristics and biomedical applications. With the development of nanomaterials, metal oxide nanoparticles show promising and far-ranging prospect for biomedical field, especially for antibacterial, anticancer drug/gene delivery, cell imaging, bio sensing, and so on ZnO NPs have emerged a promising potential in biomedicine, especially in the fields of anticancer and antibacterial fields. In addition, zinc is well known to keep the structural integrity of insulin. So, ZnO NPs also have been effectively developed for antidiabetic treatment. Moreover, ZnO NPs show excellent luminescent properties and have turned them into one of the main candidates for bio imaging.

Compared with other metal oxide NPs, ZnO NPs with the comparatively inexpensive and relatively less toxic property exhibit excellent biomedical applications, such as anticancer, drug delivery, antibacterial, and diabetes treatment; anti-inflammation; wound healing; and bio imaging

(a) Anticancer Activity

Cancer, a condition of uncontrolled malignant cell proliferation, is typically treated by chemotherapy, radiotherapy, and surgery in the past several decades. Although all these therapies seem to be very effective for killing cancer cells in theory, these nonselective therapy methods also introduce a lot of serious side effects. Recently, nanomaterial-based Nano medicine, with high biocompatibility, easily surface functionalization, cancer targeting, and drug delivery capacity, has demonstrated the potential to overcome these side effects. Zn^{2+} is an essential nutrient for adults, and ZnO nanomaterials are considered to be safe in vivo. Taking into account these advantages, ZnO NPs can be selected as biocompatible and biodegradable Nano platforms and can also be explored for cancer treatment

1.5 Synthesis of Nanomaterials

Nanomaterials are synthesized by physical and chemical method. Both type of synthesis contains some advantage and disadvantages. The selection of method depends upon character of nanoparticle that should be synthesized.

1.5.1 Physical Method

(i) Inert gas evaporation

This method is used for single element metals, alloys and ceramics. The substance is evaporated in a high vacuum chamber in presence of an inert gas. The vaporized metal atoms collide with the inert gas atom to form clusters which are collected on a cold surface.

(ii) Sputtering

This method is used to fabricate multilayered Nano composite materials. This method involves the ejection of atoms or clusters of materials by subjecting them into an accelerated and highly focused beam of inert gas such as Argon or Helium and collected by sputtered atoms on a temperature-controlled substrate.

1.5.2 Chemical Methods

The instrumentation involved in the chemical synthesis can be relatively simple and inexpensive compared to many physical methods. Nanoparticles synthesized by chemical method are known as colloids. Materials are obtained in the form of liquid but can be converted into dry powder or thin films quite easily.

(i) Chemical Precipitation

The reaction in aqueous or non-aqueous solutions containing a soluble or suspended salt followed by precipitation. The synthesized compounds are characterized by their small particle size, high homogeneity and stoichiometry which could not be attained at high temperature.

(ii) Mechano-Chemical method

The silver (Ag) powder was synthesized in a Mechano-Chemical (MC) process by including a solid-state displacement reaction between silver chloride (AgCl) and copper (Cu). The AgCl and Cu were ground in atmosphere conditions using a planetary ball mill. The reaction caused the mixture of AgCl and Cu to change to composition of the mixture, such as Ag and copper chloride (CuCl). CuCl was separated from MC process by leaching with ammonium hydroxide and we obtained Ag powder as the final product. Moreover, ascorbic acid (C₆H₈O₆) was used as the additive to improve dispersion of Ag powder during MC process. The ground powders, formed in the presence of additive, were characterized by X-Ray Diffraction (XRD) and Scanning Electron Microscope (SEM). The XRD determined that the reaction between AgCl

and Cu was complete in almost all the experiments carried out. SEM examinations revealed that the size of the particles in synthesized metallic Ag powder was in the range of 30-300 nm.

(iii) *Reduction method*

Silver nanoparticles were prepared by chemical reduction method. Silver nitrate was taken as the metal precursor and hydrazine hydrate as a reducing agent. For the preparation of silver nanoparticles two stabilizing agents, Sodium Dodecyl Sulphate (SDS) and Citrate of sodium were used for the synthesis of silver nanoparticles, silver nitrate solution (from 1.0 mm to 6.0 mm). Sodium Dodecyl Sulphate (SDS) was used as a metal salt precursor and a stabilizing agent respectively. Hydrazine hydrate solution with a concentration ranging from 2.0 mm to 12 mm and Citrate of sodium solution (1.0 mm to 2.0 mm) were used as reducing agents. Citrate of sodium was also used as a stabilizing agent at room temperature. The transparent colorless solution was converted to the characteristic pale yellow and pale red color when citrate of sodium was used as stabilizing agent. The occurrence of color was indicated the formation of silver nanoparticles.

(iv) *Sonochemical preparation*

Colloidal dispersions of bimetallic nanoparticles composed of gold and palladium were prepared by a sonochemical method. In which Au (III) and Pd (II) ions in an aqueous solution of sodium tetrachlorocuprate (III)dehydrate and sodium tetrachloropalladate (II) were reduced by ultrasound irradiation in the presence of Sodium Dodecyl Sulfate (SDS). In addition to the stabilizing effect, SDS remarkably enhanced the reduction rate probably due to the thermal decomposition that occurs at the interfacial region between cavitation bubbles and bulk solution and provides reducing radicals. Transmission Electron Microscopy (TEM) photographs showed spherical particles whose size had a fairly narrow distribution with a geometric mean diameter about 8 nm.

1.5.3 Using Plant Extracts

Green synthesis of gold and silver nanoparticles of various shapes using the leaf and petal extract of *Hibiscus rosa-sinensis* is reported.

The synthesis of nanoparticles by conventional, physical and chemical methods has adverse effects like critical conditions of temperature and pressure, expensive and toxic chemicals, long reflux time of reaction, toxic byproducts etc. A quest for an environmentally sustainable synthesis process has lead to a few biomimetic approaches. Biomimetics is the term used to when biological principles are applied in material formation.

Green synthesis of nanoparticles has gained significant importance in recent years and has become one of the most preferred method. Green synthesis of nanoparticle is an innovative branch of nanotechnology. It depends on plant source and the organic compound in the crude leaf extract.¹⁸It can generate nanoparticles of high dispersity, high stability and

narrow size distribution. Green synthesis is gaining attention due to its cost effective, ecofriendly and large-scale production possibilities.

Using Hibiscus petal extract:

Hibiscus rosa-sinensis is rich in polyphenolic phytochemicals like tannins and phenolic proteins, triterpenoids, 2,3-hexanediol, n-Hexadecenoic acid, 1,2-Benzenedicarboxylic acid and squalene. These compounds have good antimicrobial, anti-oxidative and anti-proliferative activity. In addition, these phytochemicals are believed to act as capping agent to stabilize the synthesized nanoparticles and to prevent its aggregation.

1.6 Characterization of Nanoparticle

Nanomaterials dispersed in the form of colloids in solutions, particles or thin film are characterized by various technique like X-Ray Diffraction (XRD), Transmission Electron Microscope (TEM), Scanning Electron Microscope (SEM), Atomic Force Microscope (AFM), IR and UV-Visible spectroscopic methods. Although these techniques to be used would depend upon the type of material and information one needs to know like size, crystalline type, composition, chemical state, optical and magnetic properties etc.

1.6.1 Scanning Electron Microscope (SEM)

SEM uses backscattered electrons from a sample for imaging. Typically, electrons are accelerated up to 30Kev and resolution up to 3-5 nm can be achieved. A cold cathode emits electrons under the application of a very high electric field. It is also known as field emitter such SEMs are known as FESEM and are able to give better images than hot filament SEM. The electron beam can be focused to a very small spot size using electrostatic lenses. The fine beam is scanned on the sample surface using a scan generator and backscattered electrons are collected by an appropriate detector. Signal from scan generator along with amplified signal from the electron collector generates image of the sample surface.

When an electron beam is interacting with matter, several processes occur. Inelastic scattering occurs as the beam interacts with the sample and electronic excitation of the constituent atoms occurs. These excitations can lead to valence and core electron excitation and emission. The core hole thus created may get filled by an electron de-excitation resulting in X-rays. The de-excitation can also result in electron ejection called auger emission. In addition, collision of the primary beam can also lead to excitation of lattice vibration. All these electrons can be used to gather microscopic information of the sample. In addition, they can also be used to obtain chemical or compositional information as in the case of auger electrons or structural information as in the case of back scattered electrons.

1.6.2 Transmission Electron Microscope (TEM)

The TEM uses a high voltage electron beam to create an image. The electrons are emitted by an electron gun commonly fitted with a tungsten filament as the electron source.

The electron beam is accelerated by an anode typically at 100KeV with respect to cathode; focused by electrostatic and electromagnetic lenses and transmitted through the specimen that is in part transparent to electron in part scatters them out of the beam.

When it emerges from the specimen, the electron beam carries information about structure of the specimen that is magnified by the objective lens system of the microscope. The special variation in this information is vied by projecting the magnified image in to a fluorescent viewing screen coated with phosphor or scintillated material such as zinc sulfide. The image can be photographically recorded by exposing a photographic film or plate directly to the electron beam, or a high-resolution phosphor may be coupled by means of a lens optical system or CCD camera. The image detected by the CCD may be displayed on a monitor or computer.

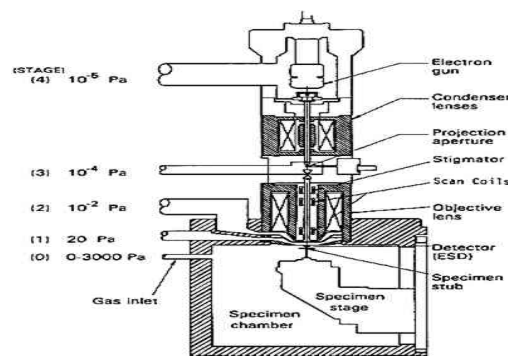

Figure 3. Transmission Electron Microscopy

1.6.3 X-ray Diffraction (XRD)

X-ray crystallography is a method of determining the arrangement of atoms with in a crystal, in which a beam of X-ray strikes a crystal and diffracts in too many specific directions. From the angles and intensities of the diffracted beam a crystallographer can be produce a three-dimensional picture of the density of electron with in crystal. Analysis of these diffraction patters allows obtain information such as lattice parameter, crystal structure, sample orientation, and particle size. We will only mention that lattice parameters are obtained from the Bragg formula: $2d \sin \theta = n\lambda$

The intensity of the diffracted X-ray is measured as a function of a diffraction angle 2θ . The intensities of the spot provide information about the atomic basis. The sharpness and shape of the spot are related to the perfection of the crystal. The two-basis procedure involves either a single crystal or a powder. With single crystal, a lot of information about the structures can be obtained.

1.6.4 UV-Visible spectroscopy

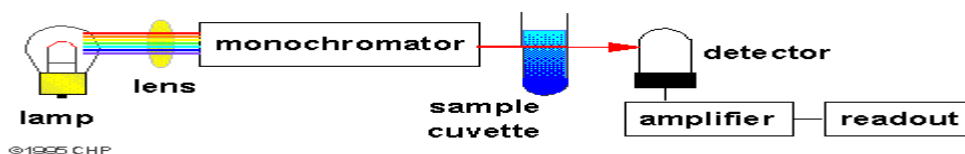

Figure 4. UV-Visible spectrophotometer

UV-Visible spectroscopies are most often liquids, although the absorbance of gases and even of solids can be measured. Samples are typically placed in a transparent cell, known as a cuvette. Cuvettes are typically rectangular in shape, commonly with an internal width of 1 cm. the type of sample container used must allow radiation to pass over the spectral region of interest. The most widely applicable cuvettes are made of high-quality fuse silica or quartz glass because these are transparent through the UV visible and near IR regions. Using this technique, we can find d absorbance (a), path length (b), concentration(c), by using Beer-Lambert's law

Where, a=molar absorption coefficient,

b=path length, c=concentration

1.6.5 FTIR spectroscopy

In Fourier transform spectroscopy allowing only one wavelength at a time to pass through the detector, this technique lets through a beam containing many different wavelengths of light at once, and measures the total beam intensity. Next, the beam is modified to contain a different combination of wavelengths, giving a second data point. This process is repeated many times. Afterwards a computer takes all this data and works backward to infer how much light there is at each wavelength. To be more specific, between the light source and the detector, there is a certain configuration of mirrors that allows some wavelengths to pass through but blocks others. The beam is modified for each new data point by moving one of the mirrors; this changes the set of wavelengths that can pass through.

As mentioned, computer processing is required to turn the raw data (light intensity for each mirror position) into the desired result (light intensity for each wavelength). The

raw data is sometimes called an “interferogram”. Because of the existing computer equipment requirements and the ability of light to analyze very small amounts of substance, it is often beneficial to automate many aspects of the sample preparation.

1.7 AIMS AND OBJECTIVES

AIM

To synthesize ZnO Nano particles using petal extracts of Hibiscus rosa-sinensis.

The proposed work also aims to characterize the synthesized Nano particles.

OBJECTIVES

Since Zn nanoparticles have extensive pharmacological applications, this project aims to synthesize ZnO Nano particles through green synthesis. The characterization of synthesized zinc nanoparticles was done using UV-Visible spectroscopy and X-Ray Diffraction (XRD) studies.

Plant extracts mediated synthesis of metal oxide nanoparticles has been developed to minimize the toxic and harmful impacts of chemical and physical methods. The present study is a green approach to synthesize zinc oxide nanoparticles from the aqueous petal extract of Hibiscus rosa-sinensis. Zinc sulphate hepta hydrate ($ZnSO_4 \cdot 7H_2O$) was used as a precursor and extracts of leaves and flower petals were used for the reduction of Zinc oxide nanoparticles. The resulted reaction mixture with zinc colloids were characterized using UV-Visible spectrophotometric analysis.

CHAPTER II MATERIALS AND METHODS

(a) Materials and Methods

For the synthesis of ZnO nano particles, Zinc sulphate heptahydrate salt, ($\text{ZnSO}_4 \cdot 7\text{H}_2\text{O}$), of 98% purity (Merck), was used.

- 0.1 M $\text{ZnSO}_4 \cdot 7\text{H}_2\text{O}$ - 100 ml
- 1 M NaOH - 50 ml
- Hibiscus petal extract - 120 ml

Green Synthesis and characterization of Zinc nanoparticles

Extraction of Hibiscus petal extract:

The fresh Hibiscus petals were collected and thoroughly washed. It is then homogenized with adequate quantity of water in a mixer grinder and then filtered to remove the ungrounded particles to obtain a homogeneous mixture. The filtrate was stored in a refrigerator for the work.

Synthesis: -

The ZnO nanoparticles were synthesized by using Zinc sulphate heptahydrate as precursor salt and hibiscus petal extract. 30 ml of 1M sodium hydroxide solution was used to adjust the pH of the reaction mixture.

The preparation starts with addition of 100ml 0.1M zinc sulphate heptahydrate solution into 120ml of hibiscus petal extract solution with vigorous stirring for 30 minutes. 30ml of 1M sodium hydroxide solution was slowly added to the homogenous solution with constant stirring to obtain a greenish coloured solution. The mixture is heated to about 2 hours at 80°C . After the completion of the reaction, the solution was taken from the heating mantle and allowed to settle overnight and the supernatant solution was then discarded cautiously. A very little dilute solution of the reaction mixture is observed in a UV chamber for fluorescence.

The precipitates were separated from the solution by centrifugation and washed with distilled water. The pale white colour precipitate obtained is dried at room temperature. After drying, nanoparticles were stored in glass vial for further analysis.



Hibiscus petal extract



Hibiscus petal extract + Zn sulphate + sodium hydroxide after 2 hours of stirring

(c) Characterization of nanoparticles

Several characterization techniques are available to study solid surfaces of Nanoparticles but a single characterization method alone can be used to explain their structures.

In this study synthesized samples were studied by use of UV–Visible absorption spectroscopy from a double beam spectrophotometer in the wavelength range from 190 to 1100 nm and X-ray Diffraction (XRD) studies were also carried out to find the particle size.

CHAPTER III

RESULTS AND DISCUSSIONS

Zinc oxide nanoparticles were synthesized by green synthesis method. Hibiscus petal extracts was used as capping agent and antioxidant in nanoparticle synthesis to inhibit nanoparticle overgrowth and aggregation as well as to control the structural characteristics of the nanoparticles formed during there reduction process in a precise manner.

The creamy white color characteristic of well-defined zinc metal nanoparticles is essentially obtained after 2 hours of heating around 80⁰C and is much darker at other times. It also appears that the particles have stability under ambient atmosphere. The mechanism responsible for the change in color remains unclear: It may be due to reduction, redissolution of the particles, or both at the same time.

Identification of Nano particle formation.

Fluorescence from metal nanoparticles, falls in the visible region due to sp-d band transition of electrons, the fluorescence gets enhanced due to interaction with localized surface plasmon.¹⁷. The fluorescence obtained in the reaction mixtures are clear indication of nanoparticle formation.



In the presence of UV light

3.1 Characterization nanoparticles

X-ray Diffraction Pattern of Zinc Nanoparticles

X - ray crystallography was used as a method of determining the arrangement of atoms within a crystal and also the size of the copper nanoparticle from Debye Scherrer equation. The result of the x-ray diffraction (XRD) analysis of zinc nanoparticles are plotted in the figure below.

Zn-4/2 (Coupled TwoTheta/Theta)

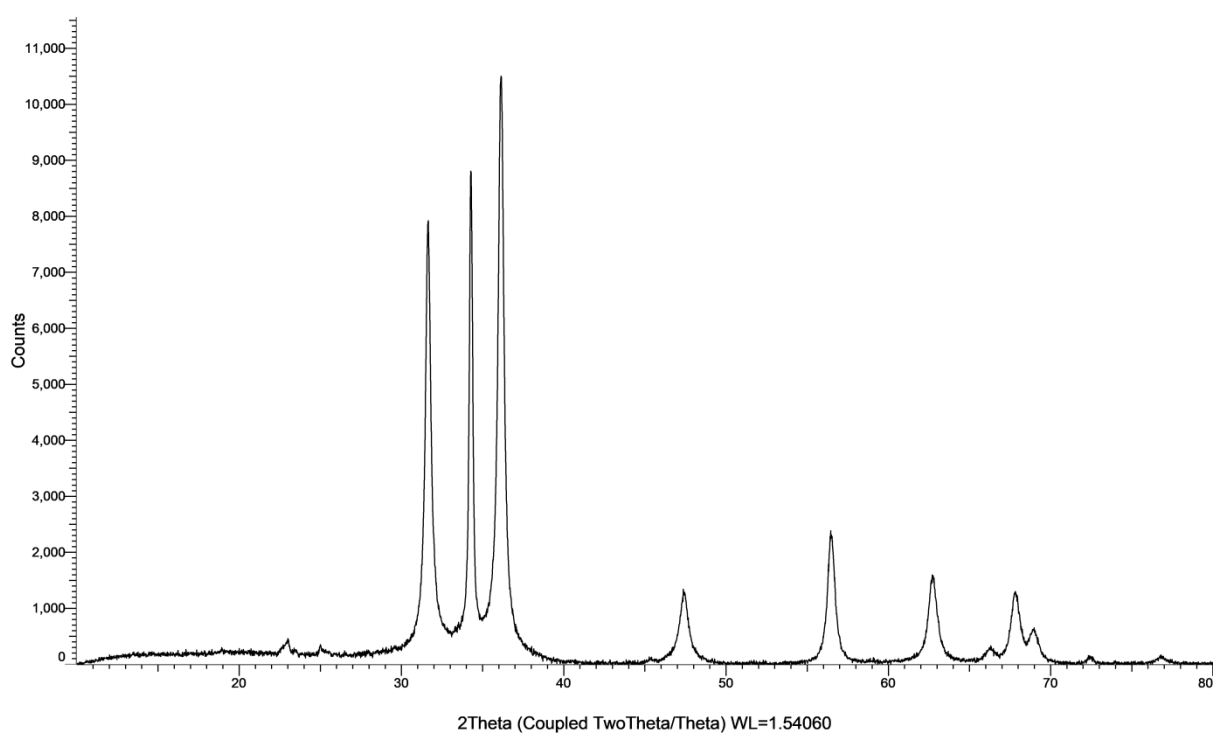

Zn-4/2 (Coupled TwoTheta/Theta)

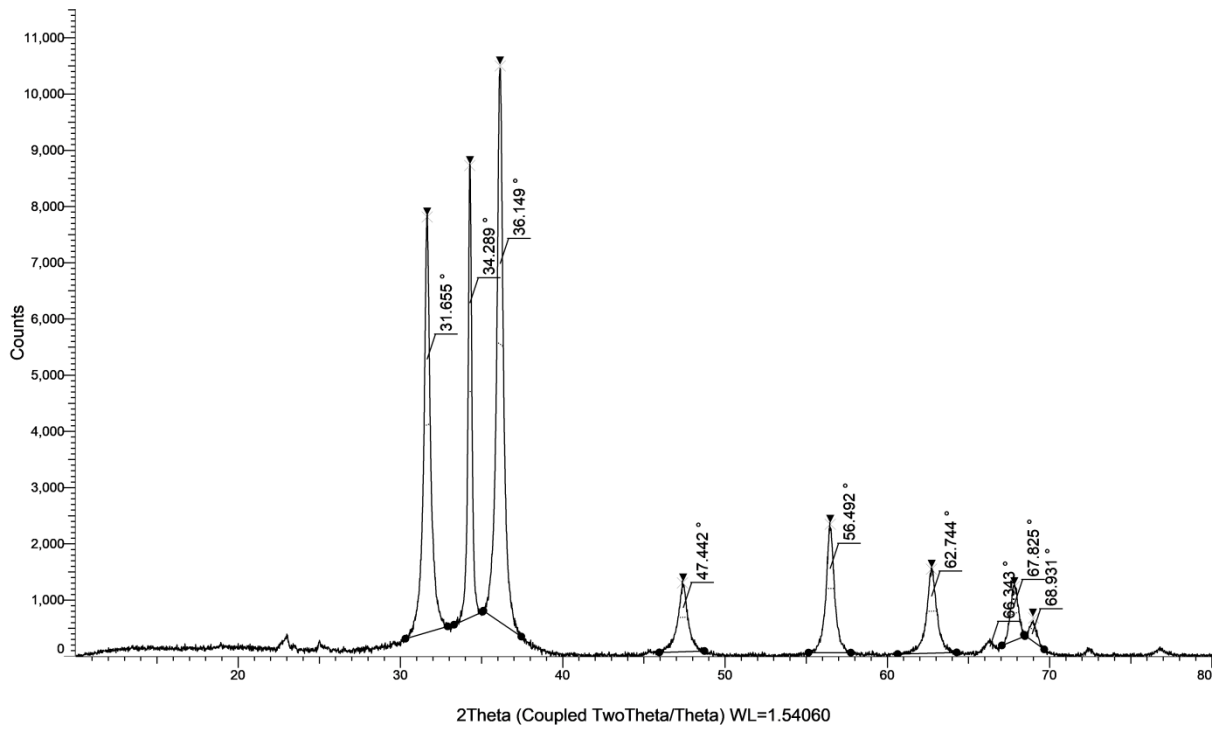

It exhibits the XRD pattern of the synthesized zinc nanoparticles. The high intensity Peak were observed at 2Θ valued of

- 36.149° forthe sample

The peak broadening in the XRD Pattern indicates the presents of small nanocrystals.

The mean size of nanocrystals was measured from the broadening of the diffraction peaks corresponding to the most intensive reflections. Scherrer equation was used to determine the crystallite size from XRD diffraction pattern measured for nanoparticles:

$$D = k \lambda / \beta \cos\Theta$$

Where K is the Scherrer constant (0.89), β is full width at half maximum (FWHM) which can be obtained from the XRD pattern, Θ is the diffraction angle, d is the averaged dimension of crystallites in nanometers and λ is the wavelength of X-ray used which can be obtained from Bragg's equation, $n\lambda = 2d \sin \Theta$, where $n=1$; Θ and d can be obtained from XRD pattern.

For sample

$$2\Theta=36.149$$

$$\Theta=18.0745$$

$$\Lambda=1.5406$$

$$\beta=0.403$$

Therefore,

$$D = \frac{0.89 \times 1.5406 \times 180}{0.403 \times \cos(18.075) \times 3.14 \times 10} = 20.516 \text{ nm}$$

The size of the Zn nanoparticle calculated from the above spectrum using the Scherrer equation is equal to 20.516 nm

UV–Visible spectrum of Zinc Oxide Nanoparticles

The zinc oxide nanoparticles shows peaks between 350nm and 380nm. These peaks may be due to the Plasmon resonance of zinc oxide nanoparticle.

Small metal nanoparticles exhibit the absorption of UV-visible electromagnetic region by the collective oscillation of conduction electrons at the surface. This is known as the surface plasmon resonance effect. The interest in this effect is the possibility of using it as a tracer for the presence of metal Nano particles with a simple UV-visible spectrometer.

The size dependence of the Plasmon resonance for particles smaller than 20 nm is a complex phenomenon. One interesting feature is the increase in the bandwidth of the resonance with the decrease in the size of the particles due to electron scattering enhancement at the surface. The shift in the resonance and the variation in its bandwidth are thus interesting parameters to characterize the metal nanoparticles.

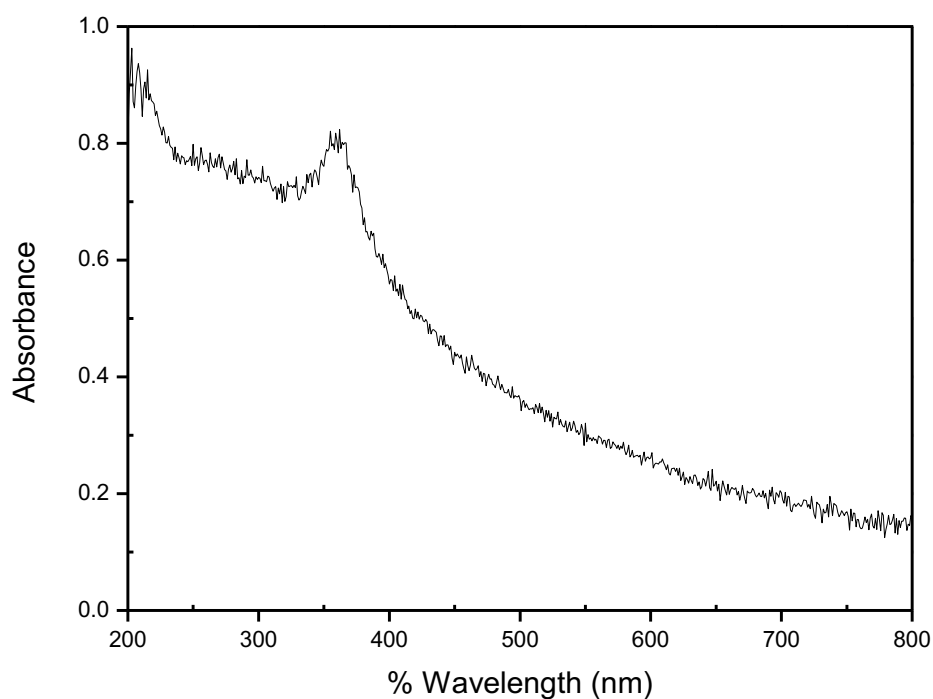

CHAPTER IV

CONCLUSION

The zinc oxide nanoparticles were synthesized from $\text{ZnSO}_4 \cdot 7\text{H}_2\text{O}$ by green synthesis method, using NaOH to regulate pH.

Zinc oxide nanoparticles were synthesized by using petal extracts of flower *Hibiscus rosa-sinensis* as capping agent. Zinc oxide nanoparticles prepared by this method shows a particle size of 20.516 nm and a absorbance peaks at between 350nm and 380nm due to a phenomenon called surface plasmon resonance effect (SPRE).

Characterization of the nanoparticles is done by UV-Visible spectroscopy and X-ray Diffraction (XRD).

The fluorescence, the UV – Visible spectrum and XRD studies showed that the present study illustrates a simple and convenient method for synthesis zinc oxide nanoparticles through the reduction of zinc salt using *Hibiscus* flower extract.

REFERENCES

1. Charles T. Poole Jr., Frank J. Owens: Introduction to nanotechnology, Wiley India Pvt. Limited (2013)
2. Anandha Krishna Rao: Nanotechnology tools & techniques, Adhyayan Publishers & distributors (2010)
3. T. Pradeep: Nanothe essentials (Understanding nanoscience & nanotechnology), Tata Mcgraw Hill Education Pvt. Limited (2013)
4. Paulo J. Ferreira & Michael F. Ashby: Nanomaterials (Nanotechnology and design), Elsevier Academic Press (2009)
5. Shaalini Suri: Nanotechnology, APH Publishing Corporation (2006)
6. Jürgen Schulte: Nanotechnology, Wiley India Pvt. Limited (2005)
7. Richard Booker & Earl Boysen: Nanotechnology, Wiley India Pvt. Limited (2011)
8. Sergeev G. B.: Nanochemistry, Elsevier Academic Press (2006)
9. Dieter Bimberg & Nikolai Ledentsov: Nanostructure, Springer (2007)
10. Journal of Nanomaterials volume 2014 (2014), Article ID 980545
11. Shenmar, R., Norsten, V.B., Rotello, V.M.: Polymer-mediated nanoparticle assembly: structural control and applications. *Adv. Matter.* 6, 657-669 (2005).
12. Balzani, V., Credi, A., Venturi, M.: The bottom-up approach to molecular-level devices and machines. *Chem. A Eur. J.* 24, 5524-5532 (2002).
13. Han, K.N., Kim, N.S.: Challenges and opportunities in direct write technology using nano-metal particles. *KONA powder part J.27*, 73 (2009)
14. Waseda, Y., Matsubara, E., Shinoda, K.: X-ray diffraction Crystallography: Introduction, examples and solved problems. Springer, Berlin (2011)
15. [En.wikipedia.org/wiki/nanoparticles](http://en.wikipedia.org/wiki/nanoparticles)

16. Ayesha Khan, Audil Rashid, Rafia Younas, Ren Chong: A chemical reduction approach to the synthesis of copper nanoparticles : A chemical reduction approach to the synthesis of copper nanoparticles : March 2016, Volume 6, Issue 1, pp 21–26
17. Handbook of Nanoparticles pp 961-983

18. C.M Noorjahan, S. K Jasmine Shahina, T. Deepika, Summera Rafiq: Green Synthesis and Characterization of Zinc Oxide Nanoparticles: International Journal of Scientific Engineering and Technology Research IISN 2319-8885 Vol.04, Issue.30, August-2015, Pages: 5715-5753